



LAFAYETTE

Model HB-625

**SOLID STATE
5-WATT
MOBILE 2-WAY RADIO**

Stock No. 99-3148WX



**23 Channel
Frequency Synthesized
CB Transceiver
with**



A LAFAYETTE FIRST!



LAFAYETTE RADIO ELECTRONICS CORPORATION

Installation and Operating Manual

MODEL HB-625

**23-CHANNEL
SOLID STATE 5-WATT MOBILE
2-WAY CB RADIO**

FEATURING



**Electronic Miracle of
the Space Age**

Three New Revolutionary Integrated Circuits

Revolutionary new electronic devices that are the ultimate in miniaturization and reliability. Each no larger than a tiny transistor, yet housing a complete circuit with many transistors, diodes and resistors. Provides improved performance in far less space—assures reliability for years to come.

Unique RF Noise Silencer

Super quiet RF Noise Silencer literally "chops out" ignition noise—even really weak signals become perfectly readable under the most severe noise conditions!

Unlike other simple noise limiting circuits, the RF Noise Silencer employs a multi-stage circuit to actually silence the receiver for the brief duration of each noise impulse. You get spectacular reduction of ignition noise with no distortion, no audible holes and no volume reduction.

SPECIFICATIONS

RECEIVER

CIRCUIT TYPE ..	Dual conversion superheterodyne; Crystal frequency synthesizer provides 23 crystal-controlled transmit and receive channels.
SENSITIVITY	0.7 μ V for 10 db S + N to N ratio at 30% at 1000 cps modulation.
SELECTIVITY	6 db down at 6 Kc; 45 db down at \pm 8 Kc.
INTERMEDIATE FREQUENCY	1st IF: 11.275 Mc. 2nd IF: 455 Kc.
AUDIO OUTPUT	3 watts into ext. spkr. jack.
AUXILIARY CIRCUITS	(1) 3-stage RF noise silencer (on-off). (2) Full-time automatic noise limiter (audio). (3) Crystal-controlled fine tuning (delta). (4) Adjustable squelch (5) 455 Kc mechanical filter. (6) "S" meter/RF power.

TRANSMITTER

DC POWER INPUT	5 watts
RANGE BOOST	Yields high average modulation at average voice levels (90% typical).
CARRIER DEVIATION	Not greater than \pm 800 cps on any channel (exceeds FCC requirements).
HARMONIC SUPPRESSION	Exceeds FCC requirements.
ANTENNA MATCHING	Nominal 50 Ω (may be used with 30-100 Ω antennas).

GENERAL

SEMI-CONDUCTORS	3 Integrated circuits, 18 transistors, 11 diodes.
POWER SUPPLY	11.5 to 14.5 volts DC, negative or positive ground (with internal switching).
ACCESSORIES	(1) Push-to-talk dynamic microphone. (2) DC power cable (3) Mobile mounting bracket. (4) Microphone clip.

GENERAL INFORMATION

The Lafayette HB-625 Transceiver is a combination transmitter and receiver designed for use in Class "D" operation in the 27 Mc Citizens Radio service. It is designed to meet the Federal Communications Commission requirements applicable to equipment operating in this service under class "D" emission, and not to be used for any other purpose. Part 95 of the FCC regulations defines operation in this service and the licensee is required to read and understand these regulations prior to operating a CB transmitter. Copies of Manual VI (covering the FCC regulations for the Citizens Band Radio Service) includes Part 95 and are available for \$1.25 from the Superintendent of Documents, U. S. Government Printing

Office, Washington, D. C. A station license may be obtained by submitting a properly completed Station License Application, Form 505, as directed.

It is illegal to operate the transmitter section of this transceiver prior to receiving a valid station license and "call sign". A properly completed Identification Card FCC Form 452C must be attached to the transmitter.

The unit will provide economical and reliable two-way radio communication in its intended application if installed and operated in accordance with instructions contained herein.

GENERAL DESCRIPTION

The HB-625 is an extremely compact all-transistor 2-way radio providing 23 crystal-controlled transmit and receive channels in the 27 Mc Citizens Band.

Designed and built for reliable, trouble-free performance, the HB-625 uses 3 revolutionary new devices known as Integrated Circuits (IC's) plus rugged, heat-resistant transistors in all critical areas. Current drain on 12 volts DC is exceptionally low, permitting continuous mobile operation for long periods of time . . . even with the automobile's motor switched off.

The HB-625 is designed to operate from 11.5 to 14.5 volts DC (positive or negative ground), but may also be operated from 105-120 volts, 50/60 cps AC when used with optional solid-state AC power supply unit Model 502. The transceiver may also be operated from a 6V. DC source when used with the optional DC converter unit, Model HB-505.

RECEIVER SECTION

The circuit is a highly sensitive and selective dual-conversion superheterodyne type offering fully crystal-controlled operation on all 23 CB channels (all crystals supplied). The circuit incorporates a number of features designed to provide optimum reception under virtually any conditions. Foremost among these features is a unique 3-stage RF Noise Silencing circuit which provides outstanding noise reduction -- particularly in mobile applications where noise pickup is generally a problem. The receiver also incorporates a full time Automatic

Noise Limiter in the audio stages. A built-in mechanical filter provides razor-sharp selectivity and thus assures high adjacent channel rejection. As a result, transmissions on adjacent channels rarely cause interference -- even at close range. A squelch control is incorporated which can be used to "silence" the receiver when no signals are being received. Being variable, the squelch circuit can be adjusted to provide varying degrees of sensitivity to incoming signals. The receiver also includes "Delta" tuning -- a 3-position switch which permits "fine" tuning of ± 1.8 Kc. This feature, which is crystal-controlled, permits optimum reception of stations that may be slightly off frequency. Other receiver features include an "S" meter (which also serves as RF power indicator), Automatic Volume Control, push-pull audio output stage, built-in 5x3" PM speaker and external speaker/phones jack.

TRANSMITTER SECTION

The transmitter may be operated on any channel (crystal-controlled) in the Citizens Band and uses a highly efficient circuit to develop the legal maximum of 5 watts DC power input to the final RF stage. A special feature in the transmitter is the full-time "Range-Boost" circuit which concentrates more audio power into the sidebands by providing high average modulation on all syllables. This results in a greater effective range of the transmitted signal at all times. A push-to-talk dynamic microphone (supplied) offers convenient transmit-receive switching which operates through

a relay for dependable operation. The microphone and audio stages may be used for public address operation in conjunction with an external PA speaker.

POWER SUPPLY

As supplied, the HB-625 is ready for connection to a 12 volt DC, negative ground system

(most U. S. vehicles now employ this system). However, the transceiver may be operated with a positive ground system by simply interchanging two wires terminated with push-on lugs in the unit. DC power is fed to the HB-625 by means of a plug-in cord. For safety, one lead (red) is equipped with an in-line fuse of 1.5 amps.

MOBILE INSTALLATION

DC POWER CONNECTIONS

WARNING: As supplied, the HB-625 is wired to operate from a battery source of 11.5 to 14.5 volts DC, on negative ground systems. Connecting the unit to a positive ground vehicle without making the necessary internal wiring change will severely damage the transceiver. Before making any power connections you must determine whether the vehicle has a negative or positive ground electrical system and follow the appropriate instructions below.

NEGATIVE GROUND VEHICLES

Connect the fused power lead (RED) of the DC power cord to the positive or "hot" side of the electrical system. Points normally available for this purpose are the accessory post on the ignition switch, the voltage regulator side of the ammeter or the accessory side of the fuse block. The other lead (BLACK) should be connected to the metal firewall or any other point that is connected to the vehicle chassis.

POSITIVE GROUND VEHICLES

Before using the HB-625 for operation in vehicles with a positive ground electrical system, the following internal wiring change must be made.

1. Place the transceiver upside down (speaker grille upward) with the front control panel facing to the left.
2. Remove the four Phillips head screws (two on each side of the unit) fastening the uppermost chassis cover.
3. Remove the chassis cover with caution because the speaker is connected directly into the unit by means of two leads terminated with push-type lugs.
4. Refer to Figure 1 which shows the location of the two leads (red and black) which must

be interchanged for positive ground operation. Each lead is attached to its terminal by a push-on type lug. To remove, simply pull steadily on the lug. Interchange the two leads as indicated in the diagram and push each lug down over its assigned terminal.

5. Replace the chassis cover, making sure the speaker leads are properly attached to the speaker terminals and have not become loose.
6. Connect the DC power cord as follows: Connect the fused (red) lead to the vehicle "hot" point or source (in the case of positive ground vehicles this is the negative battery side). Connect the black lead to the vehicle chassis, or any other point that is connected to the chassis.

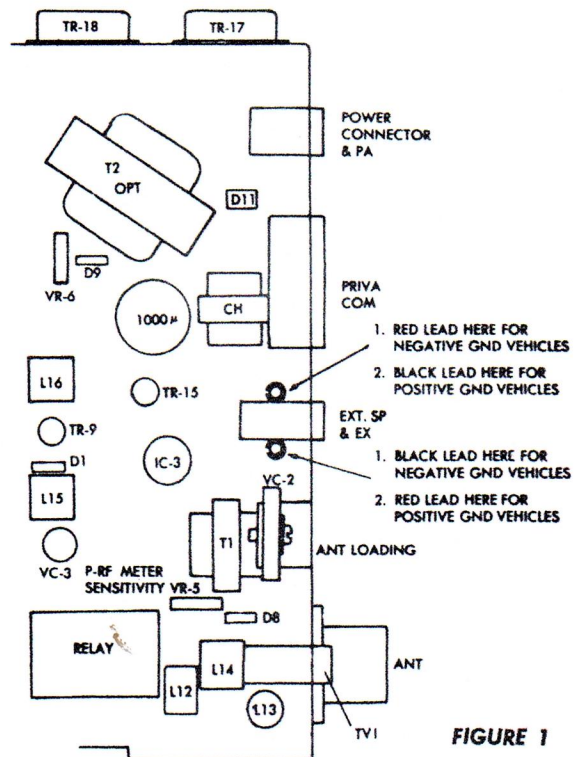

FIGURE 1

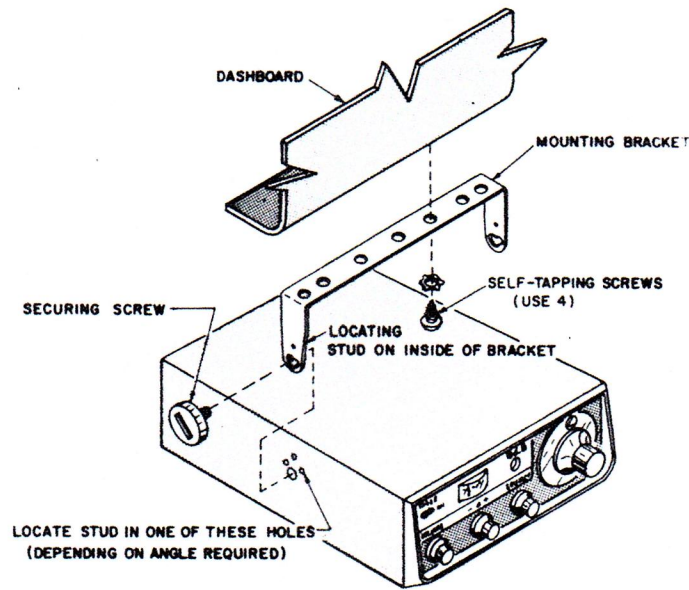

FIGURE 2.

6 VOLT DC OPERATION

The transceiver may also be operated from a 6 volt DC source by using a DC converter available for this purpose. This converter is available from Lafayette Radio as Model HB-505 (Stock No. 99-2084).

WARNING: If the vehicle has a 6 volt positive ground system, be sure to convert the HB-625 for positive ground as indicated in steps 1 thru 5 of "Positive Ground Systems" on a preceding page.

ATTACHING THE POWER CORD TO THE TRANSCEIVER

The plug at the end of the DC power cord is attached to the socket at the rear of the transceiver. Notice that the pins are unequally spaced, allowing the plug to be inserted only in one direction.

TRANSCEIVER MOUNTING

Before installing the transceiver in a car, truck, boat, etc., be sure to choose a location which is convenient to the operating controls, and will not interfere with the normal functions of the driver. The transceiver may be mounted to the underside of the instrument panel or dashboard of a car, truck, etc., by means of the special bracket that is supplied with the transceiver. Attach the bracket to the

underside of the instrument panel using four self-threading screws (See Fig. 2). Secure the transceiver to the bracket by means of the large knurled thumbscrews. The oval slot in the bracket will permit the unit to be tilted to a position which provides the operator with a better view of the front panel.

ANTENNA CONNECTION

The antenna lead-in cable (RG-58/U or RG-8/U) should be terminated with a PL-259 type male coaxial connector which should then be attached to the matching SO-239 connector at the rear of the transceiver.

MICROPHONE BRACKET

The small size of the HB-625 prohibits mounting a microphone bracket directly to the chassis. We recommend, therefore, that the microphone bracket be attached to the dashboard of the automobile or in any other convenient location. If one desires to do this without drilling holes, a magnetic mounting plate may be used and the microphone bracket attached to it.

MICROPHONE CONNECTION

Insert the 4-pin plug at the end of the coiled cord into the microphone socket at the side of the transceiver.

TV INTERFERENCE SUPPRESSION

This transceiver is equipped with a built-in series-resonant trap which offers little opposition to the transmitter output frequency but which will minimize any spurious emissions at the second harmonic (54 Mc). This trap, which is adjustable, has been preset at the factory to insure minimum TV interference, and should not require further adjustment. A procedure for adjusting the trap (when necessary) will be found in the section dealing with transmitter alignment.

IGNITION INTERFERENCE

Your transceiver is equipped with a full-time Automatic Noise Limiter plus a special RF noise silencer (switchable). One or both of these should provide efficient reduction of ignition noise. Ignition interference should not

therefore be a problem in most cases. However, sufficient noise may be generated by some vehicles to make it necessary to install additional suppression. Several noise suppressor kits are available (such as Lafayette HP-204, Stock No. 42-0905) which include all necessary parts and instructions. Alternatively, you can take the vehicle to a skilled auto radio technician who will be able to carry out the suppression for you.

AC OPERATION

As supplied, the HB-625 is designed to operate from a 12 volt DC battery source. For AC operation (house current), the solid state power supply unit Model HB-502 is required. The AC line cord from the power supply unit should be connected to an outlet supplying 105-120 volts, 50/60 cycles AC, and the DC output cable plugged into the power socket at the rear of the HB-625.

ANTENNAS

The results obtained with your new Lafayette Citizens Band Transceiver will be greatly determined by the efficiency of the antenna system used. Due to the complexity of the subject, it is not within the scope of this manual to provide detailed information on antenna systems. Although this section does contain some general information which may be of value to the beginning CB enthusiast, we suggest you purchase one of the numerous books available which covers this subject in greater detail. The Howard W. Sams publication by David E. Hicks, "CB Radio Antenna Guidebook", is particularly recommended. This book offers a complete guide to the selection and installation of CB antennas and includes a great deal of information that will be useful in obtaining optimum results with your antenna system.

MOBILE ANTENNAS

The type of antenna best suited for mobile service is a vertically polarized whip antenna. The vertical whip is non-directional and can be of the loaded type (top, center or base loaded), or a full quarter-wave, the latter usually being more efficient. Both types use the metal body of the vehicle as a "ground plane". There are a number of locations that may be used for the installation of an antenna on a car. Four of the most popular locations are those shown in Figure 3.

FRONT COWL MOUNTING

Front cowl mounting offers a number of advantages. The CB antenna can be mounted in place of the regular auto radio antenna and will thus provide the minimum of installation problems. The antenna can then be used for both the CB and standard auto radio by employing any of the commercially made two-way couplers available (such as the Lafayette HP-202, Stock No. 42-0903). In this location you can install a short loaded whip, with only a small loss of efficiency.

The horizontal radiation pattern in such a location is slightly irregular, radiation being slightly greater in the direction of the rear fender opposite to the side on which the front cowl antenna is mounted.

REAR DECK MOUNTING

Rear deck mounting permits the use of a full quarter-wave antenna or a shorter, loaded whip. The radiation pattern in such a location is somewhat irregular, radiation being slightly greater in the direction of the front fender opposite to the side on which the rear deck antenna is mounted.

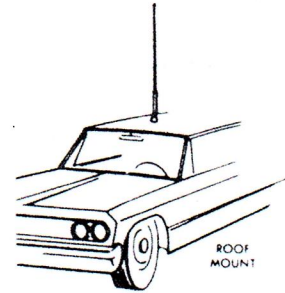
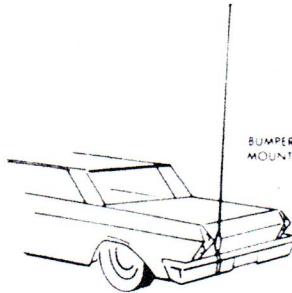
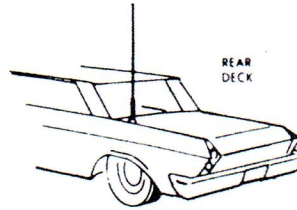
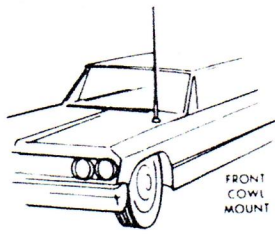

FIGURE 3

ROOF MOUNTING

Roof mounting is actually the best location because it provides an almost perfect omnidirectional radiation pattern. However, even the use of a shorter loaded whip on the roof of a vehicle is impractical in this location.

BUMPER MOUNTING

This arrangement uses the rear bumper of the car and is by far the most practical for use with full 108-inch quarter-wave whips. Another advantage is that removal of the antenna is simple and leaves no holes in the car body. The radiation pattern produced by an antenna mounted on the left rear bumper is fairly irregular, with greatest radiation being in two directions -- one to the right and forward slightly, the other to the rear and left slightly.

BASE STATION ANTENNAS

SHORT RANGE

The Lafayette HE-19 (Lafayette Stock No. 99-3015) is a small base loaded whip designed for short range communications work--intercommunication between buildings, etc. It mounts directly in the back of the transceiver. Extended, it measures 45", closed 15".

LONG RANGE

There are three basic types of long-range antennas as shown in Figure 4.

1. Vertical Ground Plane Antennas. These are omnidirectional antennas that provide optimum performance for contacting other fixed stations using vertical type antennas in addition to all mobile stations. For medium-long range communications work.
2. Coaxial Antennas. These are high efficiency type radiators with omnidirectional characteristics, performing as well in most applications as the ground plane type. Ideal for those installations where a vertical ground plane is not feasible. For medium-long range communications work.
3. Directional Beam Antennas. Highly efficient and directional antennas generally intended for "fixed-to-fixed" long range communications. An average three element beam provides an equivalent of 8 db increase in transmitter power.

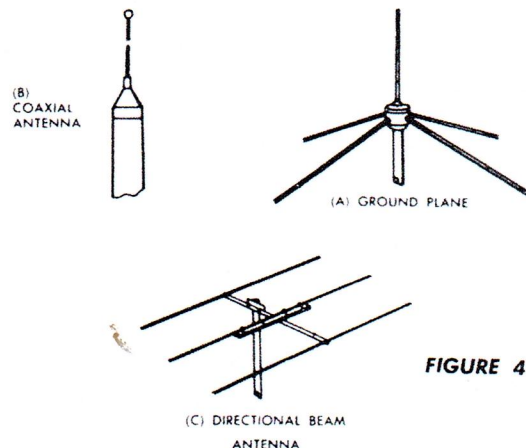
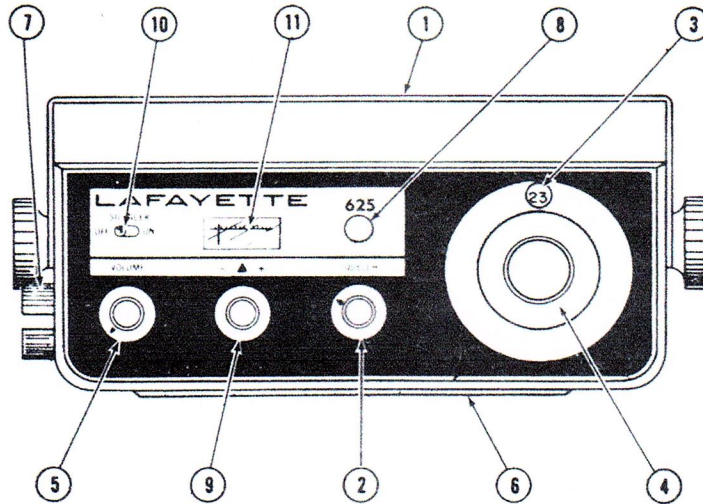
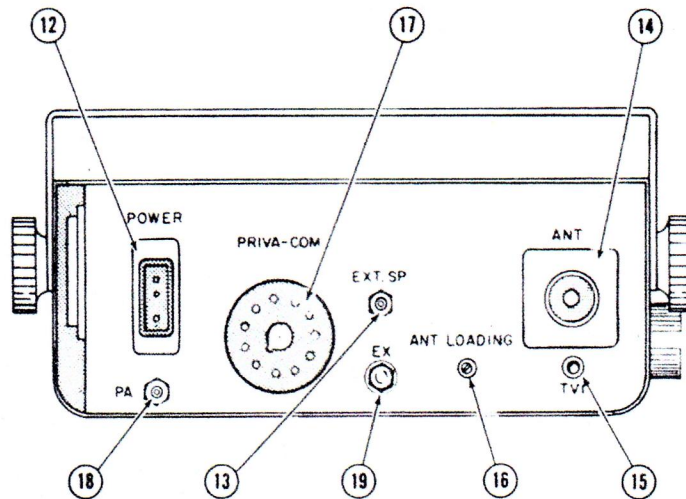

FIGURE 4



OPERATING CONTROLS AND FEATURES

- (1) MOUNTING BRACKET..... Specially designed bracket simplifies mobile installation -- has "quick-release" feature for fast removal of transceiver.
- (2) SQUELCH This control is used to "quiet" the receiver during "no-signal" conditions. Degree of sensitivity to incoming signals is adjustable. Full clockwise provides maximum squelch.
- (3) CHANNEL INDICATOR Illuminated window shows channel selected. Light is extinguished when unit is in the transmit mode.
- (4) CHANNEL..... Rotary switch selects one of 23 channels for transmit and receive operation. Also incorporates 2 extra positions, "PA" for Public Address operation (with external PA speaker connected to EXT SP jack), and "EX" for reproduction of external sources such as a tuner, tape recorder, etc.
- (5) VOLUME/ON-OFF Varies the sound output from the speaker. Also incorporates an "on-off" power switch at the extreme counter-clockwise position.
- (6) SPEAKER PM-type 4x6" oval speaker located behind grille on underside.
- (7) MICROPHONE SOCKET Four-pin socket for attachment of push-to-talk microphone (supplied).
- (8) TRANSMIT INDICATOR Lamp lights up in the transmit mode and acts as a modulation indicator.



- (9) DELTA TUNE 3-position switch (-1.8 Kc, Normal, + 1.8 Kc) which permits crystal-controlled "fine" tuning for reception of stations that are slightly off frequency.
- (10) NOISE SILENCER Switches in special RF noise silencing circuit to combat ignition noise.
- (11) ILLUMINATED METER Provides relative indication of strength of incoming signal during receive, and RF antenna power during transmit.
- (12) DC POWER SOCKET DC power for the transceiver supplied through this socket.
- (13) EXT SP Allows use of headphone for private listening, or 8-16 ohm external speaker. Insertion of plug automatically silences internal speaker.
- (14) ANTENNA RECEPTACLE For antenna lead-in cable with matching PL-259 connector.
- (15) TVI TRAP Adjustable coil for minimizing TV interference. Preset at factory and does not usually require readjustment.
- (16) ANTENNA LOADING Adjustment for matching unit to the antenna -- assures maximum radiated output.
- (17) PRIVA-COM Optional Priva-Com III Selective Call unit plugs into this socket. Unit normally equipped with jumper plug for normal use.
- (18) PA Receptacle for PA speaker (8-16 ohm).
- (19) EX Special input permits connection of tuners, tape recorders, etc., for reproduction through the speaker.

